

G5NB-EL

PCB Power Relay

A slim compact Relay with 7 A switching capacity

- 7 A (250 VAC), 5 A (30 VDC) high capacity switching with compact size.
- Minimum 200,000 operations durability at 5 A (250 VAC) switching.
- IEC/EN 60335-1 conformed.
- Ambient operating temperature: max. 85°C

RoHS Compliant

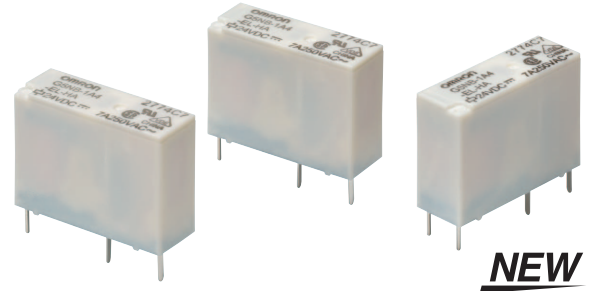

Model Number Legend

G5NB-□□□-□-□
1 2 3 4 5

- | | |
|---|---|
| <p>1. Number of Poles
1 : 1-pole</p> <p>2. Contact Form
A : SPST-NO (1a)</p> <p>3. Enclosure rating
4 : Fully sealed</p> | <p>4. Classification
EL : High capacity and electrical durability</p> <p>5. Conformity standard
HA : IEC/EN 60335-1 conformed</p> |
|---|---|

Application Examples

- Home appliances
- Industrial equipment
- Building automation

G5NB-EL

Ordering Information

Classification	Item Contact form	Enclosure rating	Model	Rated coil voltage	Minimum packing unit
Single stable relay	SPST-NO (1a)	Fully Sealed	G5NB-1A4-EL-HA	12, 24 VDC	100 pcs/Tray

Note. When ordering, add the rated coil voltage to the model number.

Example: G5NB-1A4-EL-HA 12VDC
└──────────┘ Rated coil voltage

Ratings

Coil

Item Rated voltage	Rated current (mA)	Coil resistance (Ω)	Must operate voltage (V)	Must release voltage (V)	Max. voltage (V)	Power consumption (mW)
			% of rated voltage			
12 VDC	16.7	720	75% max.	10% min.	160% (at 23°C)	Approx. 200
24 VDC	8.3	2,880				

Note 1. The rated current and coil resistance are measured at a coil temperature of 23°C with a tolerance of ±10%.

Note 2. The operating characteristics are measured at a coil temperature of 23°C.

Note 3. The "Max. voltage" is the maximum voltage that can be applied to the relay coil.

Contacts

Item	Load	Resistive load
Contact Type		Single
Contact material		Ag-alloy (Cd free)
Rated load		5 A at 250 VAC, 7 A at 250 VAC
		5 A at 30 VDC
Rated carry current		5 A at DC, 7 A at AC
Max. switching voltage		250 VAC, 30 VDC
Max. switching current		5 A at DC, 7 A at AC

Characteristics

Contact resistance *1		100 mΩ max.
Operate time		10 ms max.
Release time		10 ms max.
Insulation resistance *2		1,000 MΩ min.
Dielectric strength	Between coil and contacts	4,000 VAC, 50/60 Hz for 1 min
	Between contacts of the same polarity	750 VAC, 50/60 Hz for 1 min
Insulation distance	Between coil and contacts	Clearance: 5.5 mm, Creepage: 6 mm
Impulse withstand voltage	Between coil and contacts	10 kV (1.2 x 50 μs)
Vibration resistance	Destruction	10 to 55 to 10 Hz, 0.75 mm single amplitude (1.5 mm double amplitude)
	Malfunction	10 to 55 to 10 Hz, 0.75 mm single amplitude (1.5 mm double amplitude)
Shock resistance	Destruction	1,000 m/s ²
	Malfunction	100 m/s ²
Durability	Mechanical	5,000,000 operations min.
	Electrical (resistive load)	200,000 operations at 250 VAC, 5 A 50,000 operations at 250 VAC, 7 A 100,000 operations at 30 VDC, 5 A (with a rated load at 900 operations/h)
Failure rate (P level) (reference value) *3		DC5V 10mA
Ambient operating temperature		-40°C to 85°C (with no icing or condensation)
Ambient operating humidity		5% to 85%
Weight		Approx. 4 g

Note. The data shown above are initial value.

*1. Measurement conditions: 5 VDC, 1 A, voltage drop method

*2. Measurement conditions: Measured at the same points as the dielectric strength using a 500 VDC ohmmeter.

*3. This value was measured at a switching frequency of 120 operations/min.

Engineering Data

Maximum Switching Capacity

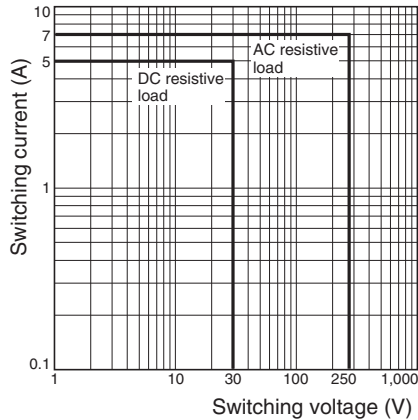

Durability

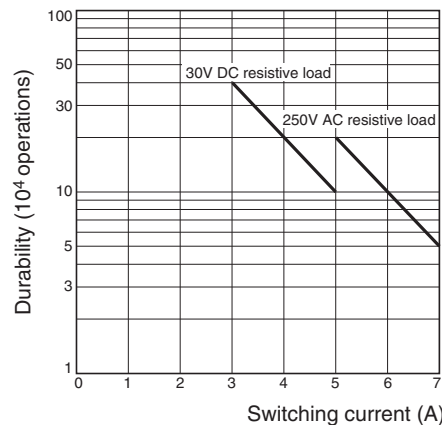

Ambient Temperature vs. Maximum Coil Voltage

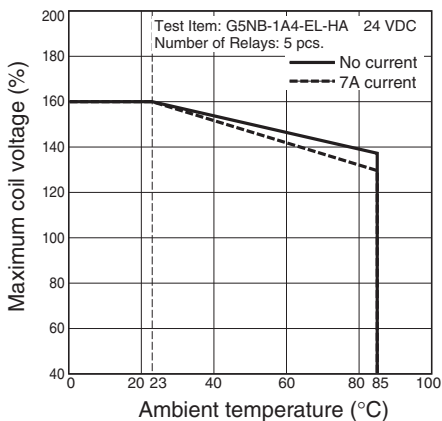

Shock malfunction

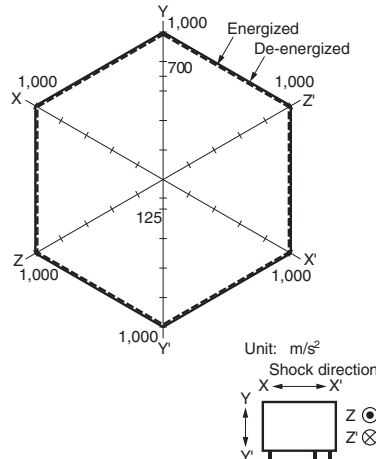

Test Item: G5NB-1A4-EL-HA 24 VDC
Number of Relays: 5 pcs

Test Method: Shock was applied 3 times in 6 directions along 3 axes and the level at which shock caused malfunction was measured.

Rating: 100 m/s²

Note: The maximum coil voltage refers to the maximum value in a varying range of operating power voltage, not a continuous voltage.

■Dimensions

(Unit: mm)

G5NB-1A4-EL-HA

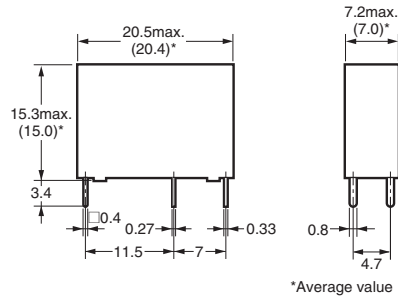

PCB Mounting Holes (Bottom View) Tolerance: ±0.1 mm

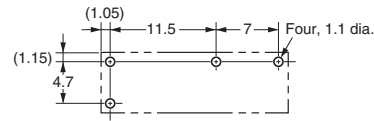

Terminal Arrangement/ Internal Connections (Bottom View)

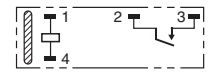

(No coil polarity)

■Approved Standards

The approval rating values for overseas standards are different from the performance values determined individually. Confirm the values before use.

●UL Recognized: (File No. E41515)

CSA Certified: (File No. LR31928)

Model	Contact form	Coil ratings	Contact ratings	Number of test operations
G5NB-1A4-EL-HA	SPST-NO (1a)	12 to 24V DC	7A 250V AC (General Purpose) 85°C	30,000
			5A 250V AC (General Purpose) 85°C	50,000
			5A 30V DC (Resistive) 85°C	6,000

●EN/IEC, VDE Certified (Registration No. 137575)

Model	Contact form	Coil ratings	Contact ratings	Number of test operations
G5NB-1A4-EL-HA	SPST-NO (1a)	12, 24V DC	7A 250V AC (Resistive) 85°C	10,000
			5A 30V DC (Resistive) 85°C	

■Precautions

●Please refer to “PCB Relays Common Precautions” for correct use.

• Application examples provided in this document are for reference only. In actual applications, confirm equipment functions and safety before using the product.
• Consult your OMRON representative before using the product under conditions which are not described in the manual or applying the product to nuclear control systems, railroad systems, aviation systems, vehicles, combustion systems, medical equipment, amusement machines, safety equipment, and other systems or equipment that may have a serious influence on lives and property if used improperly. Make sure that the ratings and performance characteristics of the product provide a margin of safety for the system or equipment, and be sure to provide the system or equipment with double safety mechanisms.

Note: Do not use this document to operate the Unit.