

VISION MINI SMART CAMERA

World's Smallest Vision System







Compact Shape/Size
ACTUAL SIZE SHOWN
 Height: 1" (25.4 mm)
 Width: 1.80" (45.7 mm)
 Length: 2.10" (53.3 mm)

The Vision MINI smart camera is designed specifically for reliable vision performance in embedded identification and inspection applications. As the world's smallest fully integrated vision system, the Vision MINI's ultra-compact size and wide angle optics provide the best performance available for machine vision tasks at close range.

With the Vision MINI, OEM design engineers can quickly implement robust inspection, color matching, symbol decoding, OCR and more in a single compact vision solution.

Vision MINI: At a Glance

- Ultra-compact shape and size
- Complete with processor, lens, illumination and AutoVISION® software for easy integration into embedded applications
- Simultaneously inspect multiple part features
- Storage for multiple jobs
- Mono and color sensor options

-  **AutoVISION Software (WVGA/SXGA only):** Provides a simple setup and runtime interface for solving basic to mid-range vision applications.
-  **VISIONScape Software (QXGA standard; WVGA/SXGA optional):** Enables scripting and other advanced programming capabilities.
-  **Omron Microscan Link:** Allows visualization and management of tool values on external systems (PLC, PC, or HMI).
-  **CloudLink:** Displays linked tool values in a fully customizable web-based HMI on browser-enabled devices.

For more information on this product, visit www.microscan.com.

Vision MINI: Capabilities



- 1D/2D symbol decoding
- Optical Character Recognition (OCR)
- Symbol Quality Verification and OCV
- Dynamic part location
- Assembly verification
- Dimensional measurements
- Plus Visionscape Option:
 - Image transformation and scaling
 - Precision calibration
 - Custom vision tools (scripting)
 - Program control functions
 - 50+ machine vision tools

Compact & Lightweight

The Vision MINI is the world's smallest fully integrated smart camera. Its compact size allows flexible positioning in tight spaces. The lightweight and durable magnesium alloy case weighs less than 2 oz.

Autofocus

The AutoVISION button provides one button set up of targeting and autofocus, and sets internal parameters to optimize image capture.

Reliability & Longevity

The Vision MINI delivers both high performance and reliability, along with the assurance of long term availability and support. This is essential for OEMs, who require uninterrupted availability throughout the lifecycle of their products, and enables them to focus on new development instead of obsolescence issues.

Powerful Capabilities

Features a robust tool set to address a wide range of automation challenges using vision technology. AutoVISION software provides an intuitive interface, step-by-step guides, and a library of presets that allow easy set up and deployment.

Scalable System

AutoVISION software allows easy expansion to more complex vision applications through migration to full Visionscape® software.

Application Examples

- Clinical instruments
 - Tube and cap absence and presence
 - Color detection and matching
- Electronics assembly
 - Fiducial location
- Pharmaceutical packaging
- Medical devices

VISION MINI SMART CAMERA SPECIFICATIONS AND OPTIONS

FRONT

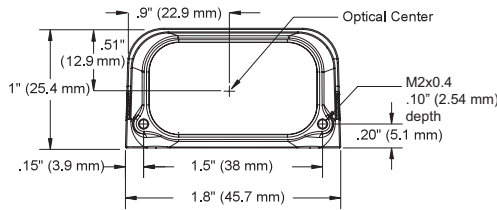

BASE

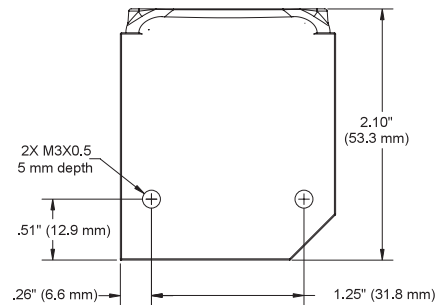

Note: Nominal dimensions shown. Typical tolerances apply.

MECHANICAL

Height: 1" (25.4 mm) **Width:** 1.80" (45.7 mm)
Depth: 2.10" (53.3 mm) **Weight:** 2 oz. (57 g)

ENVIRONMENTAL

Enclosure: IP54 (category 2)
Humidity: up to 90% (non-condensing)
Operating Temperature: 0° to 40° C (32° to 104° F)
Storage Temperature: -50° to 75° C (-58° to 167° F)

CE MARK

General Immunity for Light Industry:
 EN 55024 ITE Immunity Standard
Radiated and Conducted Emissions of ITE Equipment: EN 55022 ITE Disturbances

LIGHT SOURCE

Type: High output LEDs

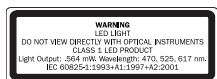

SYMBOLGY TYPES

2D Symbologies: Data Matrix (ECC 0-200), QR Code, Micro QR Code, Aztec Code, Dot Code
Stacked Symbologies: PDF417, Micro PDF417, GS1 Databar (Composite & Stacked)
Linear Barcodes: Code 39, Code 128, BC 412, I2 of 5, UPC/EAN, Codabar, Code 93, Pharmacode, PLANET, PostNet, Japanese Post, Australian Post, Royal Mail, Intelligent Mail, KIX

INDICATORS

LEDs: Trigger, Pass, Fail, Mode, Power, Link/Act
Green Flash: Pass
Blue V: Target locator

SENSOR OPTIONS

Progressive scan, square pixel.
Shutter: Software adjustable 10 μs to 16.7 ms
Shutter Type: Global (WVGA), Rolling (SXGA, QXGA)
Sensor: 1/2 inch
WVGA: CMOS 752 x 480 pixels, up to 60 fps
SXGA: CMOS 1280 x 1024 pixels, up to 15 fps
QXGA (Color): CMOS 2048 x 1536 pixels, up to 5 fps

FIELD OF VIEW AND WORKING DISTANCE

WVGA/SXGA Vision MINI

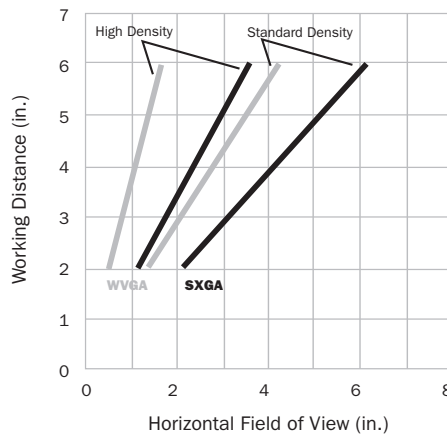

QXGA Vision MINI

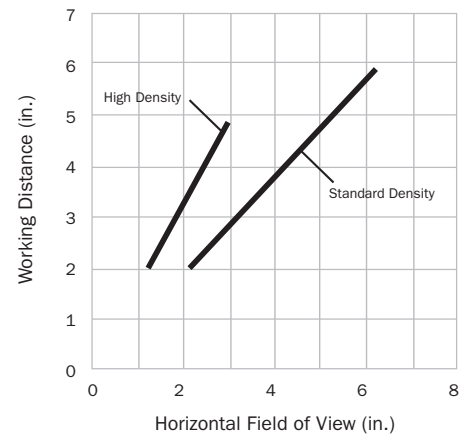

PIN ASSIGNMENTS

High Density 15 Pin D-sub Socket

Pin No.	Host RS-232	In/Out
1	Power +5 VDC	In
2	TxD	Out
3	RxD	In
4	Power/Signal Ground	
5	NC	
6	NC	
7	Output 1 TTL ^a	Out
8	Default configuration ^b	In
9	Trigger	In
10	NC	In
11	Output 3 TTL ^a	Out
12	Learn (NPN)	In
13	Chassis ground ^c	
14	Output 2 TTL ^a	Out
15	NC	

a. Can sink 10 mA and source 10 mA.
 b. The default is activated by connecting pin 8 to ground pin 4.
 c. Chassis ground: Used to connect chassis body to earth ground only. Not to be used as power or signal return.

SOFTWARE OPTIONS

WVGA, SXGA: AutoVISION included, Visionscape and Verification/OCV upgrades available
QXGA (Color): Visionscape included

IMAGING PARAMETERS

Focal Range: 2 to 6" (50.8 to 152.4 mm) (autofocus)

IMAGING RATES

WVGA: up to 60 full frame images/second
SXGA: up to 15 full frame images/second
QXGA: up to 5 full frame images/second

CONNECTOR

Type: 3 ft. cable terminated with High Density 15-pin D-Sub socket connector and USB Type B connector

ELECTRICAL POWER

WVGA: 400 mA @ 5 VDC (typ.), 4.0 watts max
SXGA: 465 mA @ 5 VDC (typ.), 4.5 watts max
QXGA: 400 mA @ 5 VDC (typ.), 4.2 watts max
Optional Int.: 10-28V with IC-332 accessory

COMMUNICATION PROTOCOLS

Standard Interface: RS-232 and/or USB 1.1 (Ethernet emulation mode driver supported)

USB Type B Socket

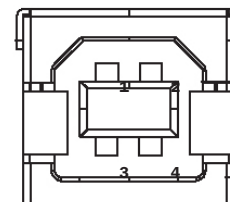

No.	Function
1	Vbus (5V)
2	D-
3	D+
4	Ground

DISCRETE I/O

Trigger Input: 5 to 28 VDC rated (.16 mA)
Learn: 5 to 28 VDC rated (.16 mA)
Outputs (1, 2, 3): 5V TTL compatible, can sink 10 mA and source 10 mA
Optional I/O: Optoisolated (with IC-332 accessory)

QMS CERTIFICATION

www.microscan.com/quality

©2018 Omron Microscan Systems, Inc. SP071J-EN-0218
 Read Range and other performance data is determined using high quality Grade A symbols per ISO/IEC 15415 and ISO/IEC 15416 in a 25° C environment. For application-specific Read Range results, testing should be performed with symbols used in the actual application. Omron Microscan Applications Engineering is available to assist with evaluations. Results may vary depending on symbol quality. **Warranty**—For current warranty information on this product, please visit www.microscan.com/warranty.



www.microscan.com